

# special tools

## Catalog



## Reamers



Category A07	HSS reamer Special high-speed steel tapered-bore straight-cut reamer. Tapered shank.
Category A15	HSS reamer Special high-speed steel cuffed reamer, specifically designed for cycling industry. With bore.
Category 121	SB stepped reamer Special coated and brazed stepped reamer with internal lubrication holes. Cylinder-shaped shank.
Category 131	SB stepped reamer Special brazed stepped reamer. Tapered shank.
Category 140	SB stepped reamer Special brazed grooved stepped reamer. Tapered shank.
Category 702	MD reamer Special coated carbide twist-cut cylindrical machine reamer. Cylinder-shaped shank.
Category 732	MD reamer Special hot-mounted carbide reamer with internal lubrication holes. Cylinder-shaped shank.
Category 737	MD stepped reamer Special carbide cylindrical stepped reamer with internal lubrication holes. Cylinder-shaped shank.



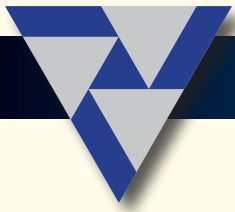

# HSS reamer



Special high-speed steel tapered-bore straight-cut reamer.  
Tapered shank.



4



Category A07



# HSS reamer



Special high-speed steel cuffed reamer, specifically designed for cycling industry.  
With bore.





# SB stepped reamer



Special coated and brazed stepped reamer with internal lubrication holes.  
Cylinder-shaped shank.



6





# SB stepped reamer



Special brazed stepped reamer.  
Tapered shank.



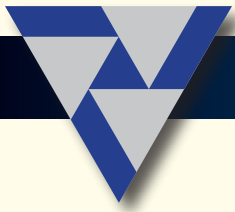

# SB stepped reamer



Special brazed grooved stepped reamer.  
Tapered shank.



8



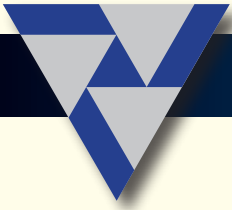

# MD reamer



Special coated carbide twist-cut cylindrical machine reamer.  
Cylinder-shaped shank.





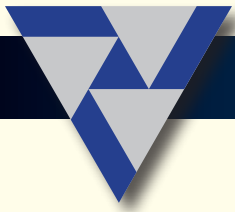

# MD reamer



Special hot-mounted carbide reamer with internal lubrication holes.  
Cylinder-shaped shank.



10



Category 732

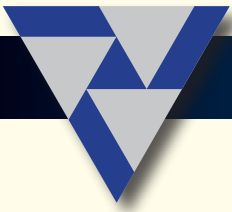

# MD stepped reamer



Special carbide cylindrical stepped reamer with internal lubrication holes.  
Cylinder-shaped shank.



## Stretchers



Category 151	SB stretcher Special brazed cylindrical machine stretcher with carbide cusp. Cylinder-shaped shank.
Category 762	MD stretcher Special coated carbide stepped stretcher. Cylinder-shaped shank.
Category 764/1	MD stretcher Special carbide stepped stretcher with internal lubrication holes. Cylinder-shaped shank.
Category 764/2	MD stretcher Special carbide stepped stretcher with internal lubrication holes. Cylinder-shaped shank.
Category 764/3	MD stretcher Special coated carbide stepped stretcher with internal lubrication holes. Cylinder-shaped shank.



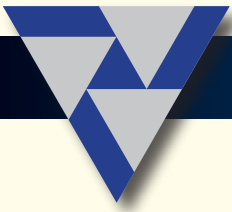

# SB stretcher



Special brazed cylindrical machine stretcher with carbide cusp.  
Cylinder-shaped shank.



14



Category 151



# MD stretcher



Special coated carbide stepped stretcher.  
Cylinder-shaped shank.



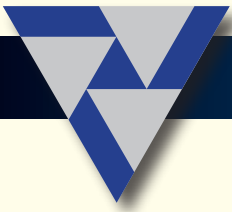

# MD stretcher



Special carbide stepped stretcher with internal lubrication holes.  
Cylinder-shaped shank.



16



Category 764



# MD stretcher



Special carbide stepped stretcher with internal lubrication holes.  
Cylinder-shaped shank.



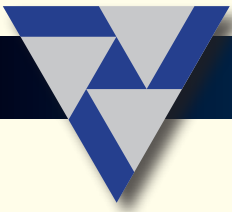

# MD stretcher



Special coated carbide stepped stretcher with internal lubrication holes.  
Cylinder-shaped shank.



18



Category 764



# Broaches



Category V18

HSS broach  
Special high-speed steel broach.



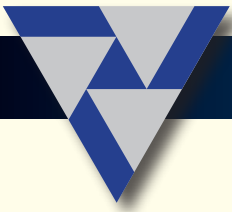

# HSS broach



Special high-speed steel broach.



# Spinnerets



Category N01

HSS spinneret  
Special high-speed steel stem-head round spinneret.

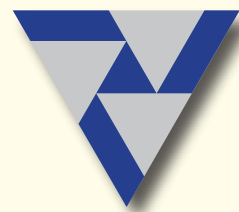

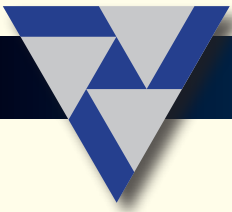

# HSS spinneret



Special high-speed steel stem-head round spinneret.



22

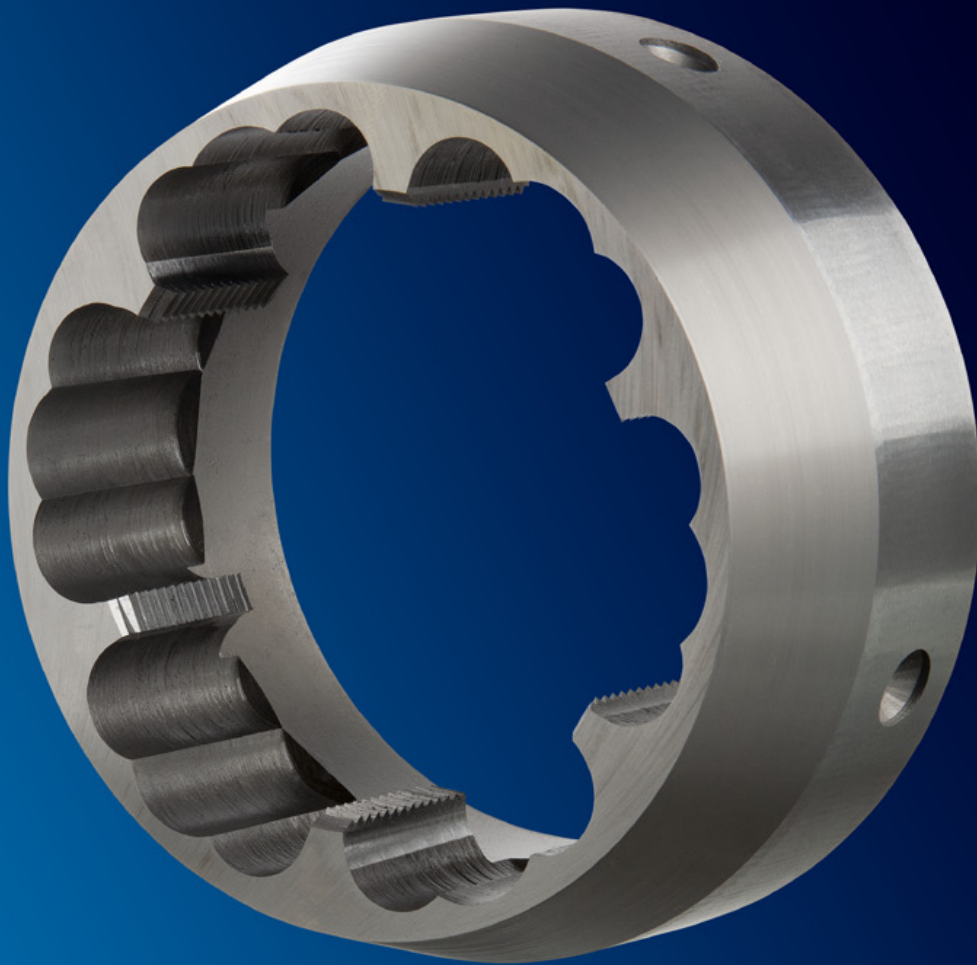

Category N01

## Milling cutters



Category F20	HSS milling cutter Special coated high-speed steel cylindrical roughing end mill, with variable-pitch twist. Cylinder-shaped shank.
Category F21	HSS milling cutter Special coated high-speed steel cylindrical roughing end mill, with swarf breaker. Special Clarkson cylinder-shaped shank.
Category F30	HSS milling cutter Special high-speed steel tapered end mill, with swarf breaker. Cylinder-shaped shank.
Category F55	HSS milling cutter Special high-speed steel double-cone prism-angle mill, for wrenches. With bore.
Category F60	HSS milling cutter Special coated high-speed steel steady-profile mill. With bore.
Category F61	HSS milling cutter Special high-speed steel shaped-profile mill. Cylinder-shaped shank.
Category F64	HSS milling cutter Special high-speed steel steady-shaped-profile cutter disc mill. With bore.
Category F87	HSS milling cutter Special high-speed steel alternating-size mill. With bore.



Category F92	HSS milling cutter Special high-speed steel shaped-profile cutter disc mill unit. With bore.
Category F107	HSS milling cutter Special high-speed steel roughing pine mill. ISO 50 tapered shank.
Category F110	HSS milling cutter Special high-speed steel end pine mill. Cylinder-shaped shank.
Category F110/2	HSS milling cutter Special coated high-speed steel end pine mill. Cylinder-shaped shank.
Category F110/3	HSS milling cutter Special coated high-speed steel end pine mill. Cylinder-shaped shank.
Category 211	SB milling cutter Special brazed cylindrical end mill. Tapered shank.
Category 235	SB milling cutter Special brazed convergent mill. Cylinder-shaped shank.
Category 801	MD milling cutter Special carbide cylindrical end mill. Cylinder-shaped shank.
Category 801/2	MD milling cutter Special carbide cylindrical end mill. Cylinder-shaped shank.
Category 801/3	MD milling cutter Special carbide cylindrical end mill. Cylinder-shaped shank.
Category 801/4	MD milling cutter Special coated carbide cylindrical end mill. Cylinder-shaped shank.

Category 801/5	MD milling cutter Special coated carbide cylindrical end mill. Cylinder-shaped shank.
Category 804	MD milling cutter Special coated carbide radial cylindrical end mill. Cylinder-shaped shank.
Category 804/2	MD milling cutter Special coated carbide radial cylindrical end mill. Cylinder-shaped shank.
Category 804/3	MD milling cutter Special carbide radial cylindrical end mill. Cylinder-shaped shank.
Category 804/4	MD milling cutter Special coated carbide radial cylindrical end mill. Cylinder-shaped shank.
Category 807	MD milling cutter Special carbide cylindrical end mill with internal lubrication holes. Cylinder-shaped shank.
Category 812	MD milling cutter Special coated carbide tapered mill. Cylinder-shaped shank.
Category 848	MD milling cutter Special coated carbide double-cone mill, for wrenches With bore.
Category 851	MD milling cutter Special coated carbide shaped-profile cutter disc mill. With bore.
Category 851/2	MD milling cutter Special coated carbide shaped-profile cutter disc mill. With bore.
Category 851/3	MD milling cutter Special coated carbide shaped-profile cutter disc mill. With bore.

Category 851/4	MD milling cutter Special coated carbide shaped-profile cutter disc mill. With bore.
Category 852	MD milling cutter Special integral carbide cutter disc mill. With bore.
Category 852/2	MD milling cutter Special coated integral carbide cutter disc mill with alternating peripheral cutting. With bore.
Category 885	MD milling cutter Special integral carbide mill. Cylinder-shaped shank.
Category 885/2	MD milling cutter Special integral carbide mill. Cylinder-shaped shank.
Category 885/3	MD milling cutter Special integral carbide mill. Cylinder-shaped shank.
Category 886	MD milling cutter Special coated carbide roughing pine mill with internal lubrication holes. Cylinder-shaped shank.
Category 890	MD milling cutter Special coated carbide end pine mill. Cylinder-shaped shank.
Category 890/2	MD milling cutter Special coated carbide end pine mill. Cylinder-shaped shank.
Category 890/3	MD milling cutter Special carbide end pine mill. Cylinder-shaped shank.
Category 890/4	MD milling cutter Special coated carbide end pine mill with internal lubrication holes. Cylinder-shaped shank.



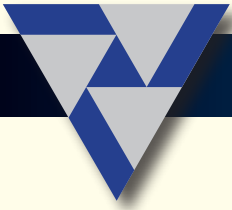

# HSS milling cutter



Special coated high-speed steel cylindrical roughing end mill, with variable-pitch twist. Cylinder-shaped shank.



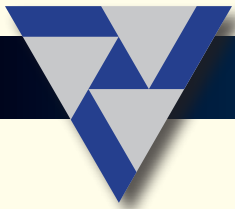

# HSS milling cutter



Special coated high-speed steel cylindrical roughing end mill, with swarf breaker.  
Special Clarkson cylinder-shaped shank.



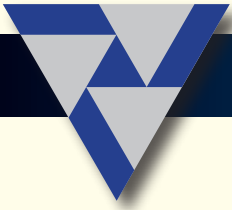

# HSS milling cutter



Special high-speed steel tapered end mill, with swarf breaker.  
Cylinder-shaped shank.





# HSS milling cutter



Special high-speed steel double-cone prism-angle mill, for wrenches.  
With bore.



30



Category F55

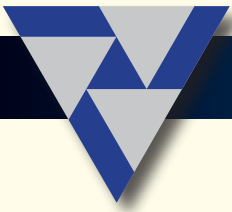

# HSS milling cutter



Special coated high-speed steel steady-profile mill.  
With bore.





# HSS milling cutter



Special high-speed steel shaped-profile mill.  
Cylinder-shaped shank.



32



Category F61



# HSS milling cutter



Special high-speed steel steady-shaped-profile cutter disc mill.  
With bore.





# HSS milling cutter



Special high-speed steel alternating-size mill.  
With bore.



34

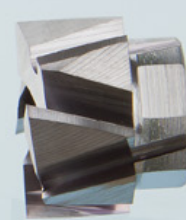

Category F87



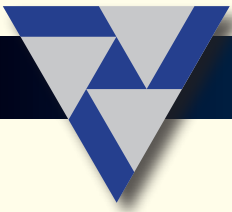

# HSS milling cutter



Special high-speed steel shaped-profile cutter disc mill unit.  
With bore.





# HSS milling cutter



Special high-speed steel roughing pine mill.  
ISO 50 tapered shank.



36



Category F107

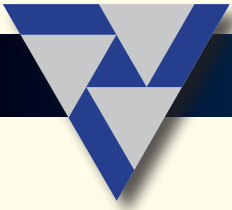

# HSS milling cutter



Special high-speed steel end pine mill.  
Cylinder-shaped shank.



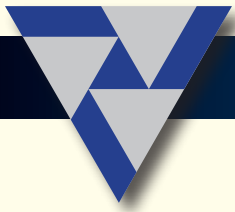

# HSS milling cutter



Special coated high-speed steel end pine mill.  
Cylinder-shaped shank.



38



Category F110

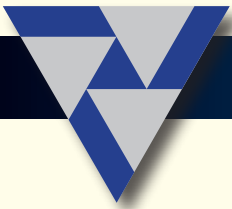

# HSS milling cutter



Special coated high-speed steel end pine mill.  
Cylinder-shaped shank.





# SB milling cutter



Special brazed cylindrical end mill.  
Tapered shank.



40



Category 211

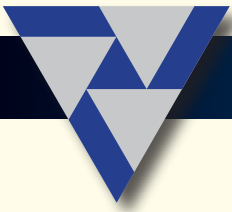

# SB milling cutter



Special brazed convergent mill.  
Cylinder-shaped shank.





# MD milling cutter



Special carbide cylindrical end mill.  
Cylinder-shaped shank.



42



Category 801



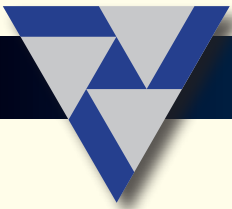

# MD milling cutter



Special carbide cylindrical end mill.  
Cylinder-shaped shank.



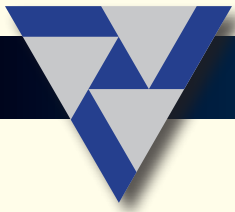

# MD milling cutter



Special carbide cylindrical end mill.  
Cylinder-shaped shank.



44



Category 801

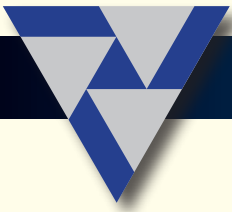

# MD milling cutter



Special carbide cylindrical end mill.  
Cylinder-shaped shank.





# MD milling cutter



Special coated carbide cylindrical end mill.  
Cylinder-shaped shank.



46



Category 801

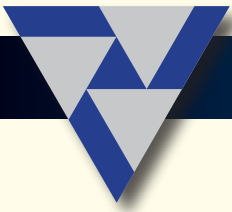

# MD milling cutter



Special coated carbide radial cylindrical end mill.  
Cylinder-shaped shank.





# MD milling cutter



Special coated carbide radial cylindrical end mill.  
Cylinder-shaped shank.



48



Category 804

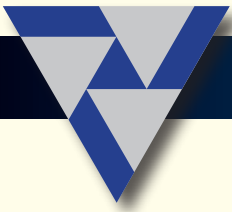

# MD milling cutter



Special carbide radial cylindrical end mill.  
Cylinder-shaped shank.



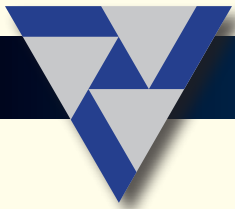

# MD milling cutter



Special coated carbide radial cylindrical end mill.  
Cylinder-shaped shank.



50



Category 804



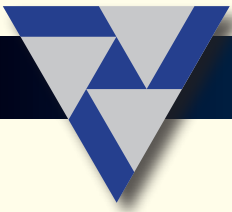

# MD milling cutter



Special carbide cylindrical end mill with internal lubrication holes.  
Cylinder-shaped shank.





# MD milling cutter



Special coated carbide tapered mill.  
Cylinder-shaped shank.



52



Category 812

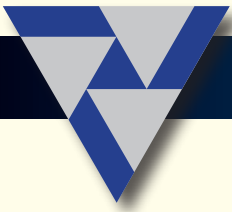

# MD milling cutter



Special coated carbide double-cone mill, for wrenches  
With bore





# MD milling cutter



Special coated carbide shaped-profile cutter disc mill.  
With bore.



54



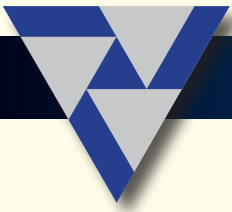

# MD milling cutter



Special coated carbide shaped-profile cutter disc mill.  
With bore.





# MD milling cutter



Special coated carbide shaped-profile cutter disc mill.  
With bore.





# MD milling cutter



Special coated carbide shaped-profile cutter disc mill.  
With bore.





# MD milling cutter



Special integral carbide cutter disc mill.  
With bore.



58



Category 852



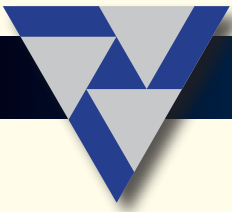

# MD milling cutter



Special coated integral carbide cutter disc mill with alternating peripheral cutting.  
With bore.





# MD milling cutter



Special integral carbide mill.  
Cylinder-shaped shank.



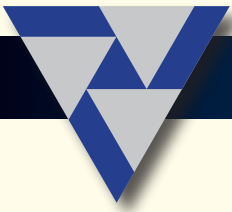

# MD milling cutter

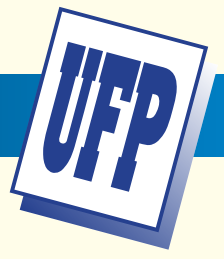

Special integral carbide mill.  
Cylinder-shaped shank.





# MD milling cutter



Special integral carbide mill.  
Cylinder-shaped shank.



62



Category 885

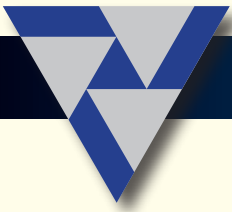

# MD milling cutter



Special coated carbide roughing pine mill with internal lubrication holes.  
Cylinder-shaped shank.





# MD milling cutter



Special coated carbide end pine mill.  
Cylinder-shaped shank.



64



Category 890

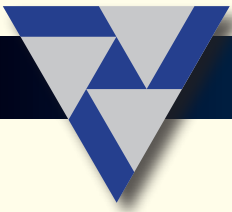

# MD milling cutter



Special coated carbide end pine mill.  
Cylinder-shaped shank.





# MD milling cutter



Special coated carbide end pine mill.  
Cylinder-shaped shank.



66



Category 890



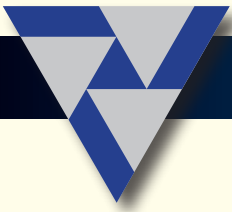

# MD milling cutter



Special coated carbide end pine mill with internal lubrication holes.  
Cylinder-shaped shank.



## Thread mills



Category F109	HSS thread mill Special coated high-speed steel pine thread mill for automatic lathes. With bore.
Category 865	MD thread mill Special carbide thread mill. Cylinder-shaped shank.
Category 865/2	MD thread mill Special carbide thread mill. Cylinder-shaped shank.
Category 865/1	MD thread mill Special carbide thread mill. Cylinder-shaped shank.



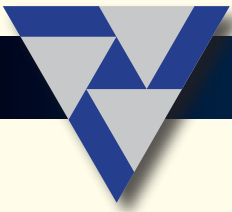

# HSS thread mill



Special coated high-speed steel pine thread mill for automatic lathes.  
With bore.



70



Category F109

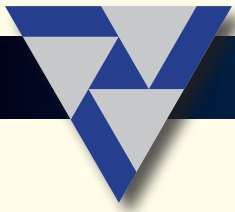

# MD thread mill



Special carbide thread mill.  
Cylinder-shaped shank.



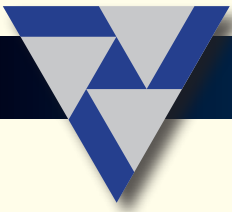

# MD thread mill



Special carbide thread mill.  
Cylinder-shaped shank.





# MD thread mill



Special carbide thread mill.  
Cylinder-shaped shank.



## Jacks



Category M04	HSS jack Special coated high-speed steel left-handed twist-cut machine jack. Reduced ripper. Cylinder-shaped shank.
Category M04/2	HSS jack Special coated high-speed steel left-handed twist-cut machine jack. Reduced ripper. Cylinder-shaped shank.
Category M13	HSS jack Special high-speed steel straight-cut cuffed jack. With bore.
Category M15	HSS jack Special high-speed steel straight-cut "Innespan" cuffed jack. Cylinder-shaped bore.
Category 996	SB jack Special brazed toothed jack, specifically designed for taps and fittings. Tapered shank.

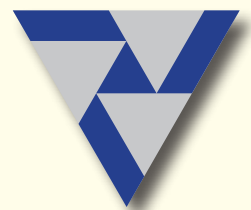

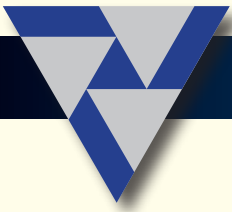

# HSS jack



Special coated high-speed steel left-handed twist-cut machine jack.  
Reduced ripper. Cylinder-shaped shank.



76



Category M04





# HSS jack



Special coated high-speed steel left-handed twist-cut machine jack.  
Reduced ripper. Cylinder-shaped shank.



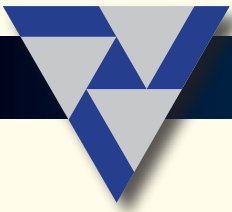

# HSS jack



Special high-speed steel straight-cut cuffed jack.  
With bore.



78



Category M13

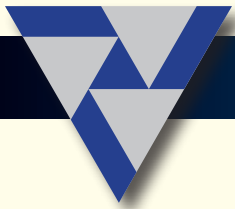

# HSS jack



Special high-speed steel straight-cut "Innespan" cuffed jack.  
Cylinder-shaped bore.

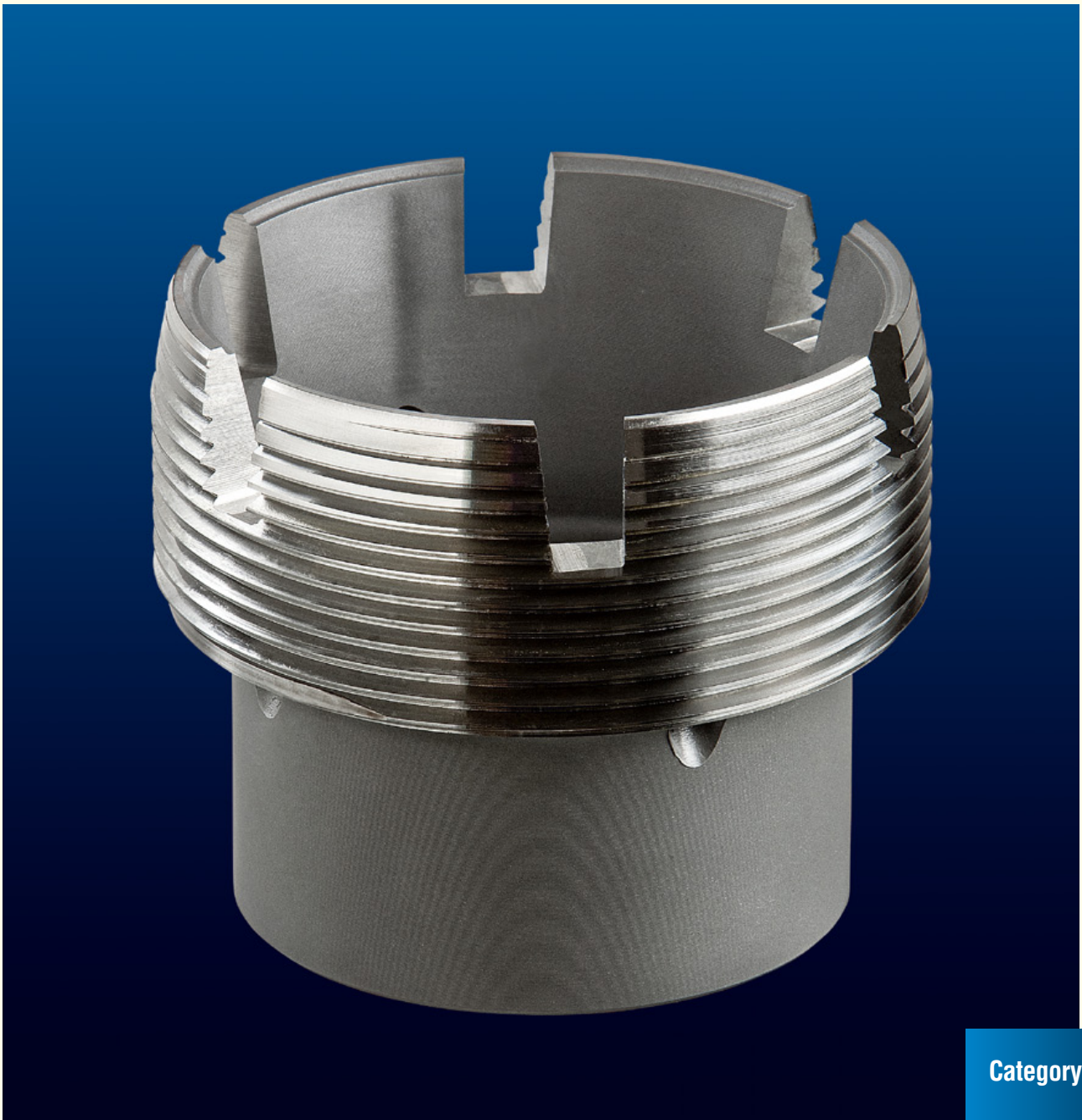

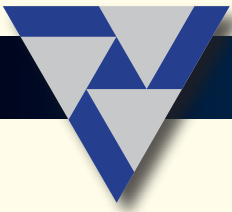

# SB jack



Special brazed toothed jack, specifically designed for taps and fittings.  
Tapered shank.



80



Category 996

## Drills



Category P15	HSS drill Special high-speed steel, ground, independent-twist stepped drill. Tapered shank.
Category P16	HSS drill Special coated high-speed steel, ground, independent-twist stepped drill. Tapered shank.
Category P30	HSS drill Special high-speed steel spot drill. Cylinder-shaped shank.
Category P30/2	HSS drill Special coated high-speed steel spot drill. Cylinder-shaped shank.
Category P30/3	HSS drill Special coated high-speed steel spot drill. Cylinder-shaped shank.
Category P60	HSS drill Special high-speed steel single-flute drill. Cylinder-shaped shank.
Category 902	MD drill Special coated carbide cylindrical twist drill. Cylinder-shaped shank.
Category 902/2	MD drill Special carbide cylindrical twist drill. Cylinder-shaped shank.



Category 902/3	MD drill Special carbide cylindrical twist drill. Cylinder-shaped shank.
Category 912	MD drill Special carbide cylindrical stepped drill. Cylinder-shaped shank.
Category 912/2	MD drill Special carbide cylindrical stepped drill. Cylinder-shaped shank.
Category 924	MD drill Special coated carbide twist-cut cylindrical stepped drill with internal lubrication holes. Cylinder-shaped shank.
Category 924/2	MD drill Special coated carbide twist-cut cylindrical stepped drill with internal lubrication holes. Cylinder-shaped shank.
Category 924/3	MD drill Special coated carbide twist-cut cylindrical stepped drill with internal lubrication holes. Cylinder-shaped shank.
Category 924/4	MD drill Special coated carbide twist-cut cylindrical stepped drill with internal lubrication holes. Cylinder-shaped shank.
Category 924/5	MD drill Special carbide stepped twist drill with internal lubrication holes. Cylinder-shaped shank.
Category 942	MD drill Special coated carbide straight-cut drill with internal lubrication holes. Cylinder-shaped shank.
Category 943	MD drill Special carbide straight-cut cylindrical stepped drill with internal lubrication holes. Cylinder-shaped shank.
Category 943/2	MD drill Special carbide straight-cut cylindrical stepped drill with internal lubrication holes. Cylinder-shaped shank.

Category 943/3

MD drill

Special carbide straight-cut cylindrical stepped drill with internal lubrication holes.  
Cylinder-shaped shank

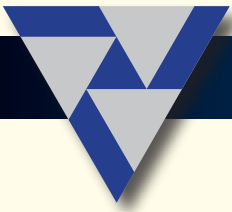

# HSS drill



Special high-speed steel, ground, independent-twist stepped drill.  
Tapered shank.







# HSS drill



Special coated high-speed steel, ground, independent-twist stepped drill.  
Tapered shank.



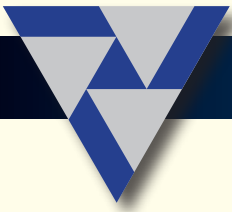

# HSS drill



Special high-speed steel spot drill.  
Cylinder-shaped shank.





# HSS drill



Special coated high-speed steel spot drill.  
Cylinder-shaped shank.



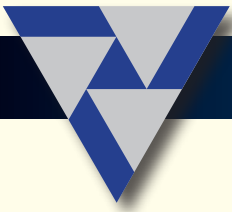

# HSS drill



Special high-speed steel single-flute drill.  
Cylinder-shaped shank.



88



Category P30

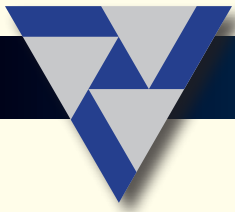

# HSS drill



Special high-speed steel single-flute drill.  
Cylinder-shaped shank.



Category P60

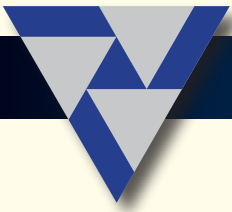

# MD drill



Special coated carbide cylindrical twist drill.  
Cylinder-shaped shank.



90



Category 902

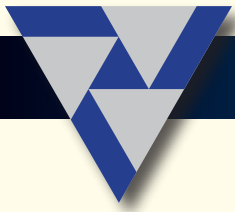

# MD drill



Special carbide cylindrical twist drill.  
Cylinder-shaped shank.



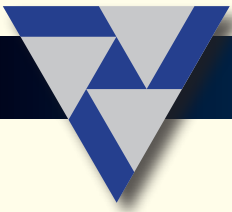

# MD drill



Special carbide cylindrical twist drill.  
Cylinder-shaped shank.



92



Category 902



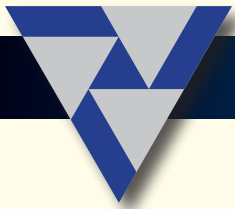

# MD drill



Special carbide cylindrical stepped drill.  
Cylinder-shaped shank.



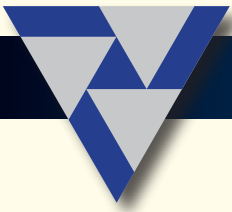

# MD drill



Special carbide cylindrical stepped drill.  
Cylinder-shaped shank.



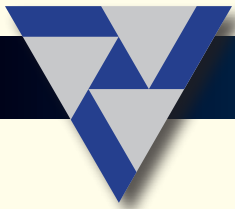

# MD drill



Special coated carbide twist-cut cylindrical stepped drill with internal lubrication holes.  
Cylinder-shaped shank.



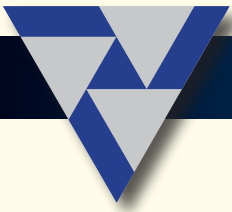

# MD drill



Special coated carbide twist-cut cylindrical stepped drill with internal lubrication holes.  
Cylinder-shaped shank.



96

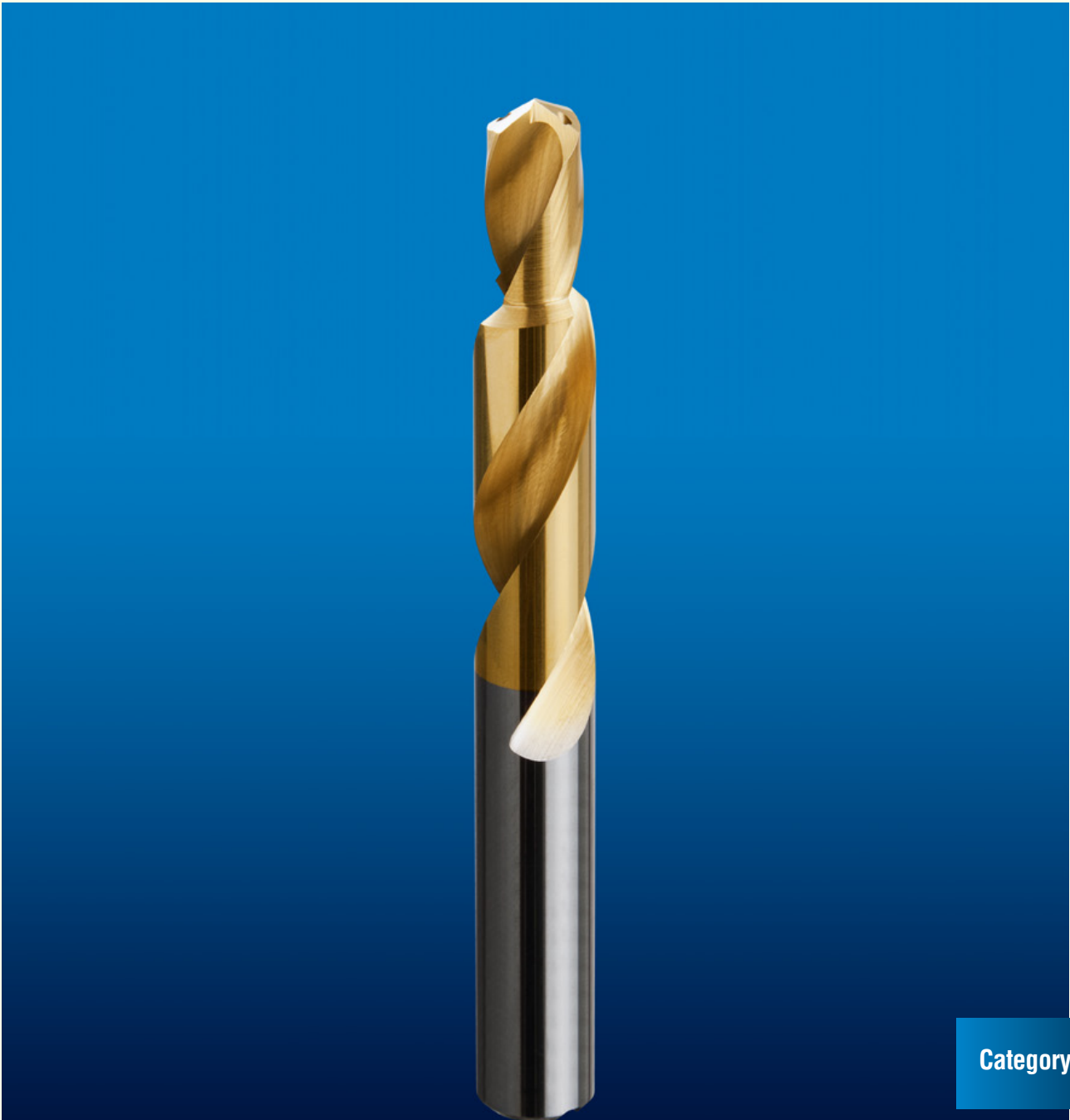

Category 924



# MD drill



Special coated carbide twist-cut cylindrical stepped drill with internal lubrication holes.  
Cylinder-shaped shank.



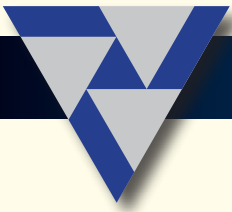

# MD drill



Special coated carbide twist-cut cylindrical stepped drill with internal lubrication holes.  
Cylinder-shaped shank.



98



Category 924

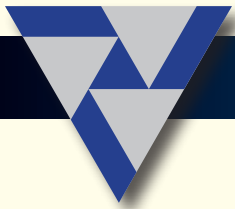

# MD drill



Special carbide stepped twist drill with internal lubrication holes.  
Cylinder-shaped shank

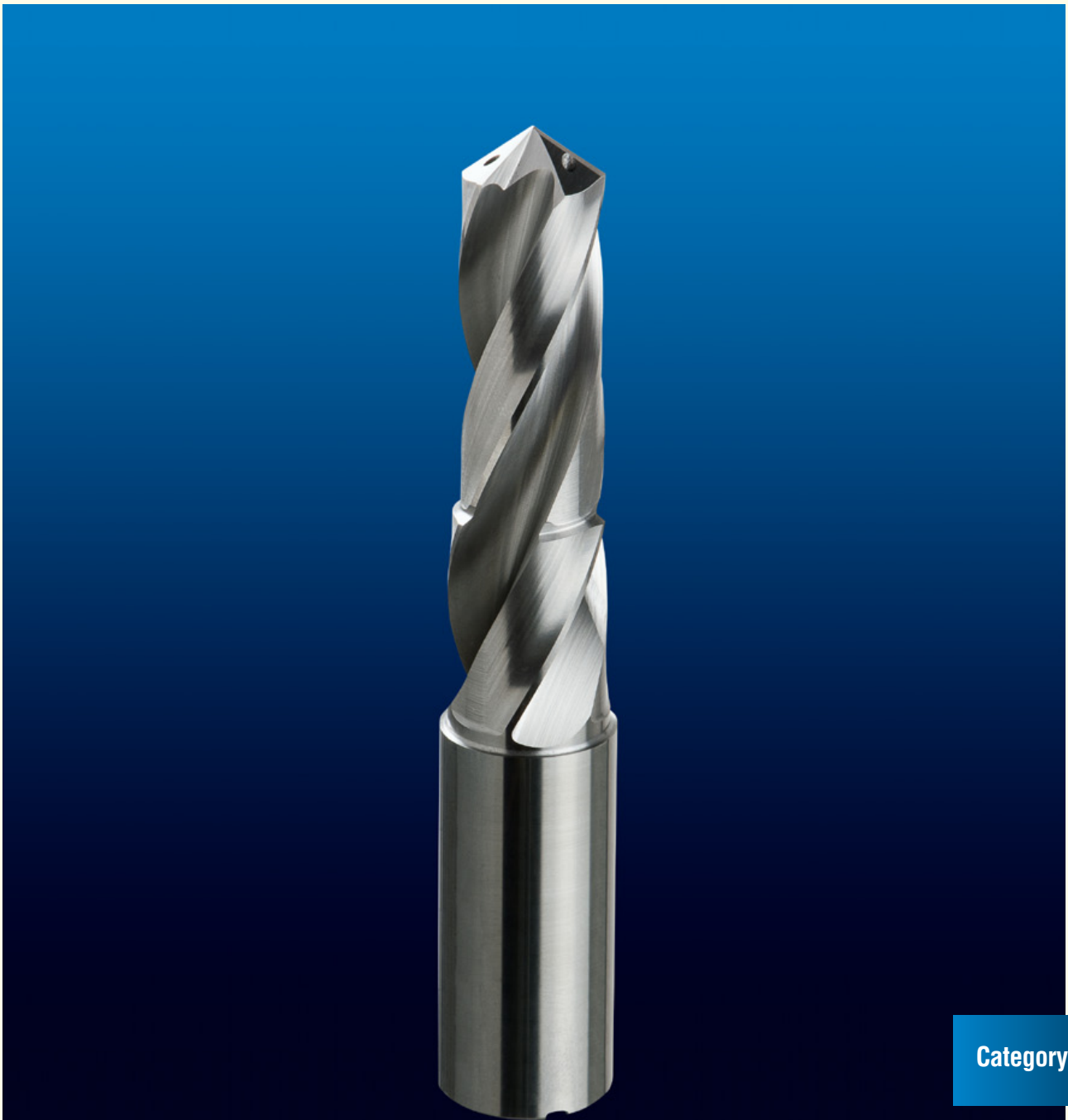



# MD drill



Special coated carbide straight-cut drill with internal lubrication holes.  
Cylinder-shaped shank.



100



Category 942





# MD drill



Special carbide straight-cut cylindrical stepped drill with internal lubrication holes.  
Cylinder-shaped shank.

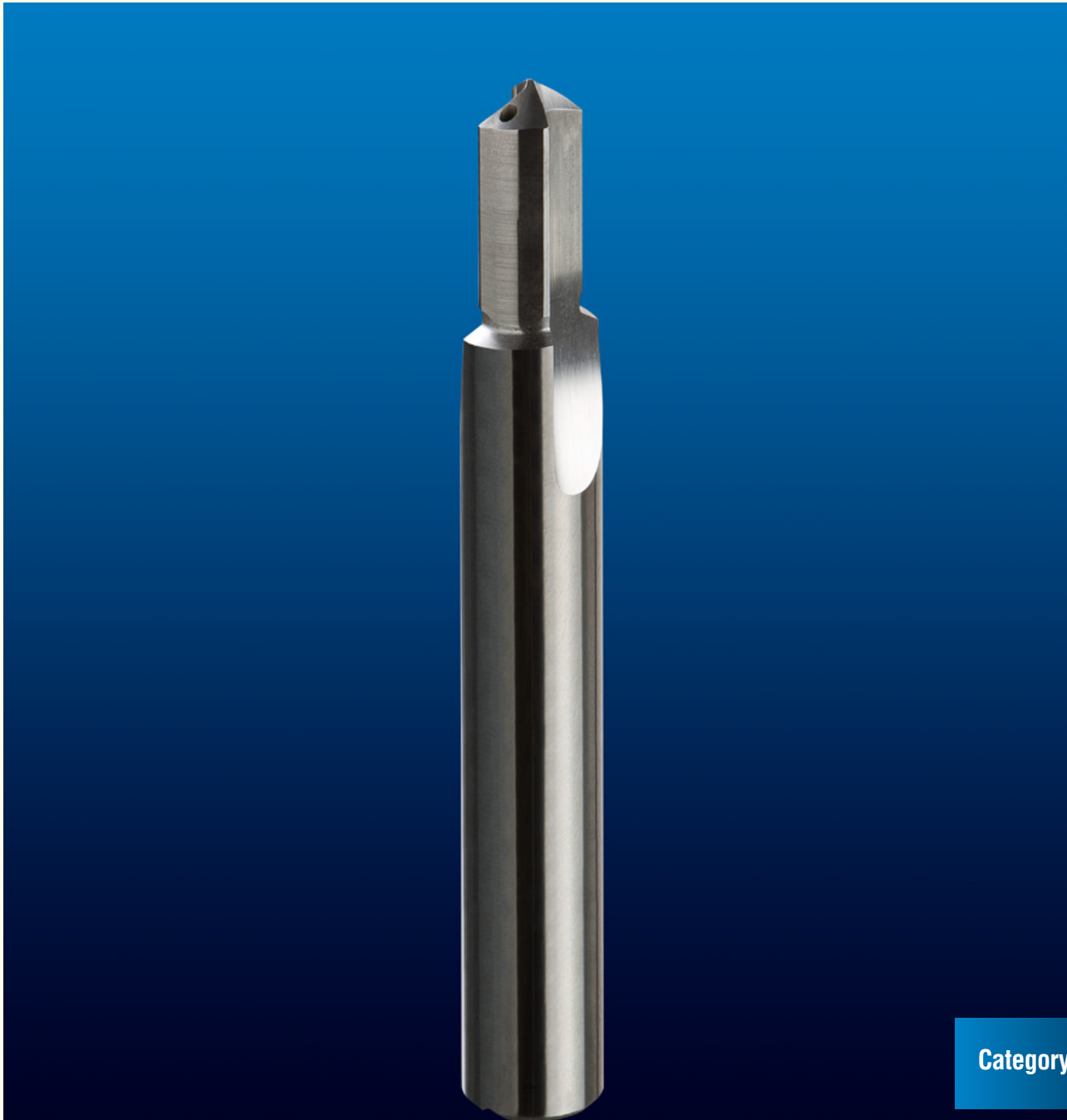

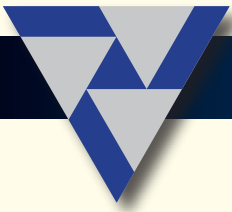

# MD drill



Special carbide straight-cut cylindrical stepped drill with internal lubrication holes.  
Cylinder-shaped shank.



102



Category 943



# MD drill



Special carbide straight-cut cylindrical stepped drill with internal lubrication holes.  
Cylinder-shaped shank.



## Circular tools



Category U10	HSS circular tool Special coated high-speed steel circular profiler tool. Generic coupling.
Category U10/2	HSS circular tool Special coated high-speed steel circular profiler tool. Generic coupling.
Category U10/3	HSS circular tool Special coated high-speed steel circular profiler tool. Generic coupling.



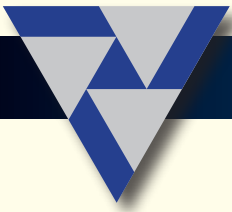

# HSS circular tool



Special coated high-speed steel circular profiler tool.  
Generic coupling.



106



Category U10



# HSS circular tool



Special coated high-speed steel circular profiler tool.  
Generic coupling.



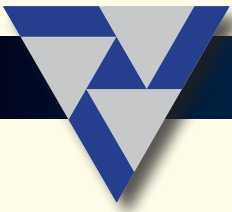

# HSS circular tool



Special coated high-speed steel circular profiler tool.  
Generic coupling.



108



Category U10

## Tangential tools



Category T01

HSS tangential tool  
Special high-speed steel tangential tool.

Category T02

HSS tangential tool  
Special coated high-speed steel tangential tool.





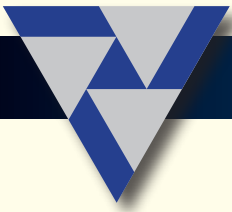

# HSS tangential tool



Special high-speed steel tangential tool.



110

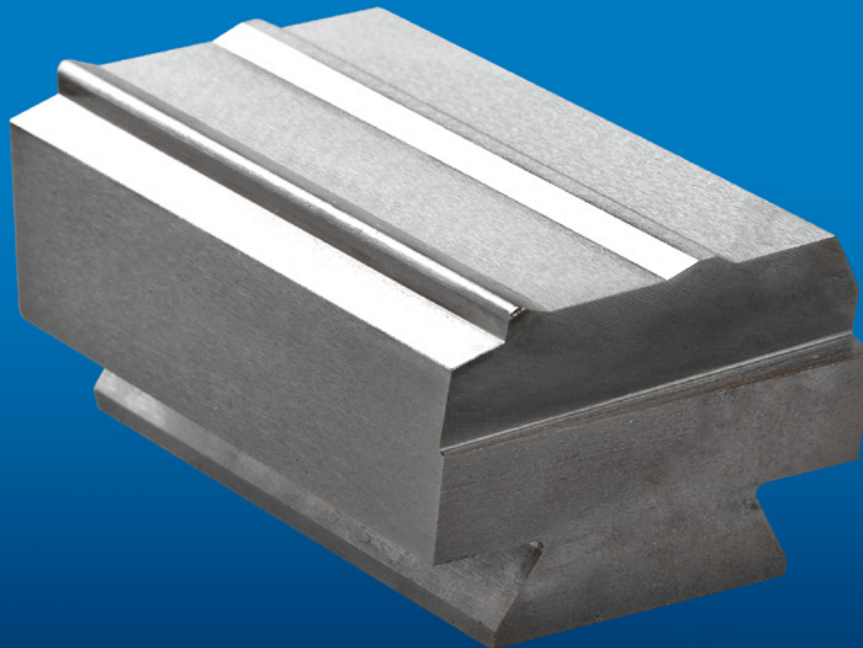

Category T01

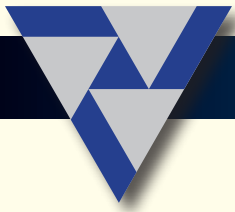

# HSS tangential tool



Special coated high-speed steel tangential tool.





UFP s.r.l.  
Via 1° Maggio, 37  
23873 Missaglia/LC (Italia)  
[www.ufp.it](http://www.ufp.it)  
[info@ufp.it](mailto:info@ufp.it)  
Tel.: +39 039 9240094 r.a.  
Fax: +39 039 9240116



UFP Sud s.r.l.  
Zona Industriale Incoronata  
71100 Foggia (Italia)  
[ufpsud@libero.it](mailto:ufpsud@libero.it)  
Tel.: +39 0881 335621 r.a.  
Fax: +39 0881 666234



CTS s.r.l.  
Via Gitti, 37  
25060 Marcheno/BS (Italia)  
[cts\\_srl@alice.it](mailto:cts_srl@alice.it)  
Tel.: +39 030 8610115  
Fax: +39 030 8610115

## UFP+BDM Herramientas

BDM Business Development Messico  
(RFC) PLH100830SY7  
Batallon de San Blas 356 colonia Niños Héroes,  
Toluca, México C.P. 50100  
[www.ufp-bdm.com](http://www.ufp-bdm.com)  
[info@ufp-bdm.com](mailto:info@ufp-bdm.com)  
Tel.: +11 52 722 2783901

# special tools factory